

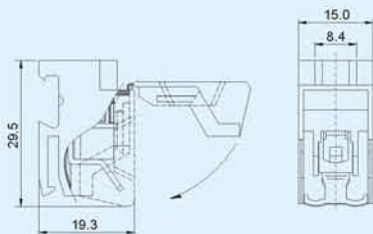

TSC 6



Pitch:15.0mm;Poles:1P

● **Material**

Screws : M4 steel Zinc plated
Contact : Copper, Tin plated
Housing : PA66, UL94V-0

● **Electrical**

Rated voltage : 750V
Rated current : 36A
Contact resistance : 20mΩ
Insulation resistance : 5000MΩ/DC1000V
Withstanding voltage: AC3000/1Min
Withstanding voltage: 24-8AWG 6.0mm²

● **Mechanical**

Temp.Range : -40°C~+105°C
Torque : 1.2Nm(10.5lb.in)
Strip length : 10-12mm

● **材质及电镀**

螺丝 : M4, 钢, 镀锌
触点材料: 紫铜, 镀锡
塑件 : PA66, UL94V-0

● **电气性能**

额定电压: 750V
额定电流: 36A
接触电阻: 20mΩ
绝缘电阻: 5000MΩ/DC1000V
耐电压 : AC3000V/1Min
使用线径: 24-8AWG 6.0mm²

● **机械性能**

温度范围: -40°C~+105°C
扭矩 : 1.2Nm(10.5lb.in)
剥线长度: 10-12mm



TSC 4

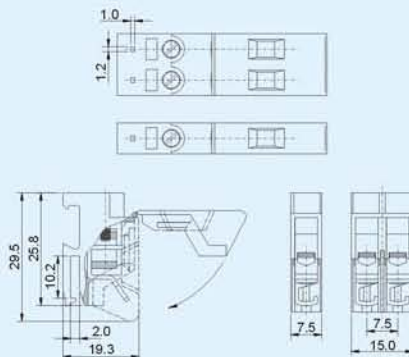

Pitch:7.5mm;Poles:1P,2P

● **Material**

Screws : M3.5 steel Zinc plated
Contact : Copper, Tin plated
Housing : PA66, UL94V-0

● **Electrical**

Rated voltage : 750V
Rated current : 20A
Contact resistance : 20mΩ
Insulation resistance : 5000MΩ/DC1000V
Withstanding voltage: AC3000/1Min
Withstanding voltage: 24-10AWG 4.0mm²

● **Mechanical**

Temp.Range : -40°C~+105°C
Torque : 0.8Nm(7.0lb.in)
Strip length : 10-12mm

● **材质及电镀**

螺丝 : M3.5, 钢, 镀锌
触点材料: 紫铜, 镀锡
塑件 : PA66, UL94V-0

● **电气性能**

额定电压: 750V
额定电流: 20A
接触电阻: 20mΩ
绝缘电阻: 5000MΩ/DC1000V
耐电压 : AC3000V/1Min
使用线径: 24-10AWG 4.0mm²

● **机械性能**

温度范围: -40°C~+105°C
扭矩 : 0.8Nm(7.0lb.in)
剥线长度: 10-12mm



TSCW 4

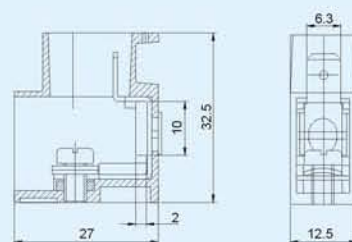

Pitch:7.5mm;Poles:1P,2P

● **Material**

Screws : M3.5 steel Zinc plated
Contact : Copper, Tin plated
Housing : PA66, UL94V-0

● **Electrical**

Rated voltage : 750V
Rated current : 20A
Contact resistance : 20mΩ
Insulation resistance : 5000MΩ/DC1000V
Withstanding voltage: AC3000/1Min
Withstanding voltage: 24-10AWG 4.0mm²

● **Mechanical**

Temp.Range : -40°C~+105°C
Torque : 0.8Nm(7.0lb.in)
Strip length : 10-12mm

● **材质及电镀**

螺丝 : M3.5, 钢, 镀锌
触点材料: 紫铜, 镀锡
塑件 : PA66, UL94V-0

● **电气性能**

额定电压: 750V
额定电流: 20A
接触电阻: 20mΩ
绝缘电阻: 5000MΩ/DC1000V
耐电压 : AC3000V/1Min
使用线径: 24-10AWG 4.0mm²

● **机械性能**

温度范围: -40°C~+105°C
扭矩 : 0.8Nm(7.0lb.in)
剥线长度: 10-12mm



TSCB 4

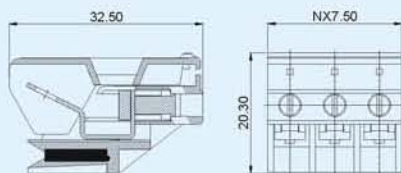

Pitch:7.5mm;Poles:1P~3P

● **Material**

Screws : M3 Brass Ni plated
Contact : Copper, Tin plated
Housing : PA66, UL94V-0

● **Electrical**

Rated voltage : 600V
Rated current : 20A
Contact resistance : 20m Ω
Insulation resistance : 5000M Ω /DC1000V
Withstanding voltage: AC3000V/1Min
Withstanding voltage: 24-10AWG 4.0mm²

● **Mechanical**

Temp.Range : -40°C~+105°C
Torque : 0.5Nm(4.4lb.in)
Strip length : 8-10mm

● **材质及电镀**

螺丝 : M3, 铜, 镀锌
触点材料: 紫铜, 镀锡
塑件 : PA66, UL94V-0

● **电气性能**

额定电压: 600V
额定电流: 20A
接触电阻: 20m Ω
绝缘电阻: 5000M Ω /DC1000V
耐电压 : AC3000V/1Min
使用线径: 24-10AWG 4.0mm²

● **机械性能**

温度范围: -40°C~+105°C
扭矩 : 0.5Nm(4.4lb.in)
剥线长度: 8-10mm



TSC 10

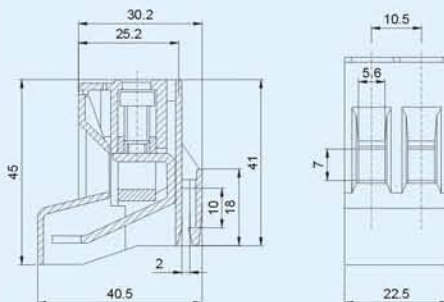

Pitch:10.5mm;Poles:2P

● **Material**

Screws : M5 steel Zinc plated
Contact : Copper, Tin plated
Housing : PA66, UL94V-0

● **Electrical**

Rated voltage : 750V
Rated current : 63A
Contact resistance : 20m Ω
Insulation resistance : 5000M Ω /DC1000V
Withstanding voltage: AC3000V/1Min
Withstanding voltage: 20-6AWG 10.0mm²

● **Mechanical**

Temp.Range : -40°C~+105°C
Torque : 2.0Nm(17.5lb.in)
Strip length : 8-10mm

● **材质及电镀**

螺丝 : M5, 钢, 镀锌
触点材料: 紫铜, 镀锡
塑件 : PA66, UL94V-0

● **电气性能**

额定电压: 750V
额定电流: 63A
接触电阻: 20m Ω
绝缘电阻: 5000M Ω /DC1000V
耐电压 : AC3000V/1Min
使用线径: 20-6AWG 10.0mm²

● **机械性能**

温度范围: -40°C~+105°C
扭矩 : 2.0Nm(17.5lb.in)
剥线长度: 8-10mm



TSCF 4

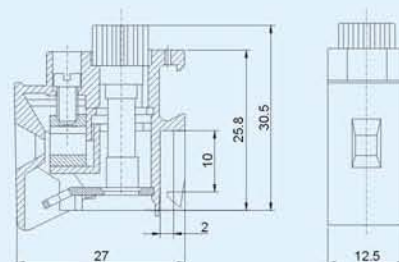

Pitch:12.5mm;Poles:1P

● **Material**

Screws : M3.5 steel Zinc plated
Contact : Copper, Tin plated
Housing : PA66, UL94V-0

● **Electrical**

Rated voltage : 250V
Rated current : 10A
Contact resistance : 20m Ω
Insulation resistance : 5000M Ω /DC1000V
Withstanding voltage: AC3000V/1Min
Withstanding voltage: 24-10AWG 4.0mm²

● **Mechanical**

Temp.Range : -40°C~+105°C
Torque : 0.8Nm(7.0lb.in)
Strip length : 10-12mm

● **材质及电镀**

螺丝 : M3.5, 钢, 镀锌
触点材料: 紫铜, 镀锡
塑件 : PA66, UL94V-0

● **电气性能**

额定电压: 250V
额定电流: 10A
接触电阻: 20m Ω
绝缘电阻: 5000M Ω /DC1000V
耐电压 : AC3000V/1Min
使用线径: 24-10AWG 4.0mm²

● **机械性能**

温度范围: -40°C~+105°C
扭矩 : 0.8Nm(7.0lb.in)
剥线长度: 10-12mm



TS 4

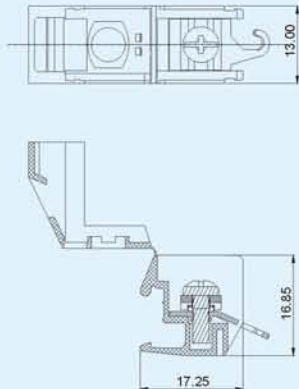

Pitch:13.0mm;Poles:1P



TS 2.5

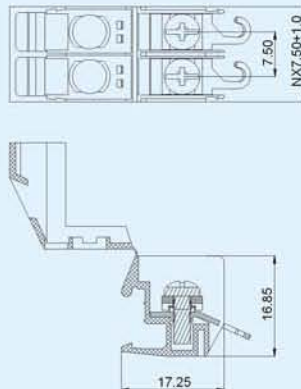

Pitch:8.0mm;Poles:1P



TSA 4

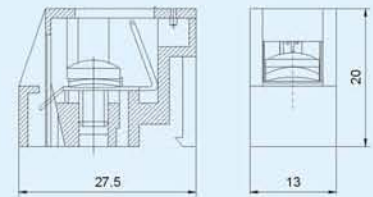

Pitch:13.1mm;Poles:1P

● **Material**

Screws : M4 steel Zinc plated
Contact : Copper, Tin plated
Housing : PA66, UL94V-0

● **Electrical**

Rated voltage : 300V
Rated current : 20A
Contact resistance : 20mΩ
Insulation resistance : 5000MΩ/DC1000V
Withstanding voltage: AC2000/1Min
Withstanding voltage: 24-10AWG 4.0mm²

● **Mechanical**

Temp.Range : -40°C~+105°C
Torque : 1.2Nm(10.5lb.in)
Strip length : 8-10mm

● **材质及电镀**

螺丝 : M4, 钢, 镀锌
触点材料: 紫铜, 镀锡
塑件 : PA66, UL94V-0

● **电气性能**

额定电压: 300V
额定电流: 20A
接触电阻: 20mΩ
绝缘电阻: 5000MΩ/DC1000V
耐电压 : AC2000V/1Min
使用线径: 24-10AWG 4.0mm²

● **机械性能**

温度范围: -40°C~+105°C
扭矩 : 1.2Nm(10.5lb.in)
剥线长度: 8-10mm

● **Material**

Screws : M3 steel Zinc plated
Contact : Copper, Tin plated
Housing : PA66, UL94V-0

● **Electrical**

Rated voltage : 300V
Rated current : 10A
Contact resistance : 20mΩ
Insulation resistance : 5000MΩ/DC1000V
Withstanding voltage: AC2000/1Min
Withstanding voltage: 24-12AWG 2.5mm²

● **Mechanical**

Temp.Range : -40°C~+105°C
Torque : 0.5Nm(4.4lb.in)
Strip length : 8-10mm

● **材质及电镀**

螺丝 : M3, 钢, 镀锌
触点材料: 紫铜, 镀锡
塑件 : PA66, UL94V-0

● **电气性能**

额定电压: 300V
额定电流: 10A
接触电阻: 20mΩ
绝缘电阻: 5000MΩ/DC1000V
耐电压 : AC2000V/1Min
使用线径: 24-12AWG 2.5mm²

● **机械性能**

温度范围: -40°C~+105°C
扭矩 : 0.5Nm(4.4lb.in)
剥线长度: 8-10mm

● **Material**

Screws : M4 steel Zinc plated
Contact : Copper, Tin plated
Housing : PA66, UL94V-0

● **Electrical**

Rated voltage : 600V
Rated current : 30A
Contact resistance : 20mΩ
Insulation resistance : 5000MΩ/DC1000V
Withstanding voltage: AC2000/1Min
Withstanding voltage: 24-10AWG 4.0mm²

● **Mechanical**

Temp.Range : -40°C~+105°C
Torque : 1.2Nm(10.5lb.in)
Strip length : 8-10mm

● **材质及电镀**

螺丝 : M4, 钢, 镀锌
触点材料: 紫铜, 镀锡
塑件 : PA66, UL94V-0

● **电气性能**

额定电压: 600V
额定电流: 30A
接触电阻: 20mΩ
绝缘电阻: 5000MΩ/DC1000V
耐电压 : AC2000V/1Min
使用线径: 24-10AWG 4.0mm²

● **机械性能**

温度范围: -40°C~+105°C
扭矩 : 1.2Nm(10.5lb.in)
剥线长度: 8-10mm



TSA 2.5

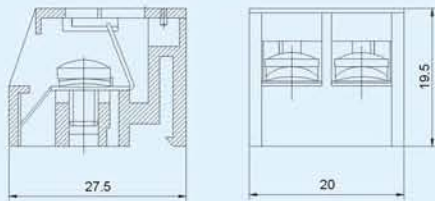

Pitch:10.0mm;Poles:2P

● **Material**

Screws : M3 steel Zinc plated
Contact : Copper, Tin plated
Housing : PA66, UL94V-0

● **Electrical**

Rated voltage : 600V
Rated current : 10A
Contact resistance : 20mΩ
Insulation resistance : 5000MΩ/DC1000V
Withstanding voltage: AC2000/1Min
Withstanding voltage: 24-12AWG 2.5mm²

● **Mechanical**

Temp.Range : -40°C~+105°C
Torque : 0.5Nm(4.4lb.in)
Strip length : 8-10mm

● **材质及电镀**

螺丝 : M3, 钢, 镀锌
触点材料: 紫铜, 镀锡
塑件 : PA66, UL94V-0

● **电气性能**

额定电压: 600V
额定电流: 10A
接触电阻: 20mΩ
绝缘电阻: 5000MΩ/DC1000V
耐电压 : AC2000V/1Min
使用线径: 24-12AWG 2.5mm²

● **机械性能**

温度范围: -40°C~+105°C
扭矩 : 0.5Nm(4.4lb.in)
剥线长度: 8-10mm



TSB 4

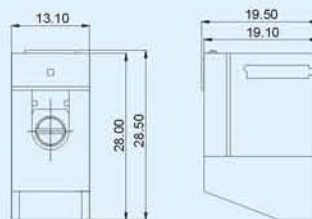

Pitch:13.1mm;Poles:1P

● **Material**

Screws : M4 steel Zinc plated
Contact : Copper, Tin plated
Housing : PA66, UL94V-0

● **Electrical**

Rated voltage : 600V
Rated current : 30A
Contact resistance : 20mΩ
Insulation resistance : 5000MΩ/DC1000V
Withstanding voltage: AC2000/1Min
Withstanding voltage: 24-10AWG 4.0mm²

● **Mechanical**

Temp.Range : -40°C~+105°C
Torque : 1.2Nm(10.5lb.in)
Strip length : 8-10mm

● **材质及电镀**

螺丝 : M4, 钢, 镀锌
触点材料: 紫铜, 镀锡
塑件 : PA66, UL94V-0

● **电气性能**

额定电压: 600V
额定电流: 30A
接触电阻: 20mΩ
绝缘电阻: 5000MΩ/DC1000V
耐电压 : AC2000V/1Min
使用线径: 24-10AWG 4.0mm²

● **机械性能**

温度范围: -40°C~+105°C
扭矩 : 1.2Nm(10.5lb.in)
剥线长度: 8-10mm



TSB 2.5

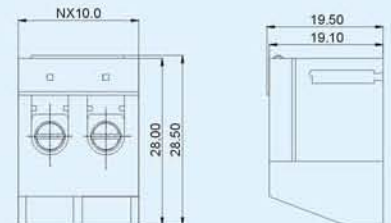

Pitch:10.0mm;Poles:2P

● **Material**

Screws : M3 steel Zinc plated
Contact : Copper, Tin plated
Housing : PA66, UL94V-0

● **Electrical**

Rated voltage : 600V
Rated current : 10A
Contact resistance : 20mΩ
Insulation resistance : 5000MΩ/DC1000V
Withstanding voltage: AC2000/1Min
Withstanding voltage: 24-12AWG 2.5mm²

● **Mechanical**

Temp.Range : -40°C~+105°C
Torque : 0.5Nm(4.4lb.in)
Strip length : 8-10mm

● **材质及电镀**

螺丝 : M3, 钢, 镀锌
触点材料: 紫铜, 镀锡
塑件 : PA66, UL94V-0

● **电气性能**

额定电压: 600V
额定电流: 10A
接触电阻: 20mΩ
绝缘电阻: 5000MΩ/DC1000V
耐电压 : AC2000V/1Min
使用线径: 24-12AWG 2.5mm²

● **机械性能**

温度范围: -40°C~+105°C
扭矩 : 0.5Nm(4.4lb.in)
剥线长度: 8-10mm



TS 10

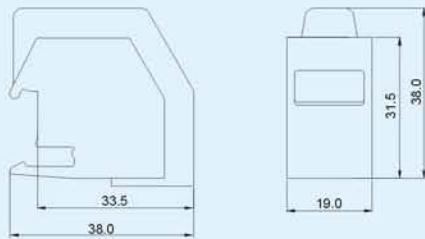

Pitch:19.0mm;Poles:1P

● **Material**

Screws : M5 steel Zinc plated
Contact : Copper, Tin plated
Housing : PA66, UL94V-0

● **Electrical**

Rated voltage : 600V
Rated current : 63A
Contact resistance : 20m Ω
Insulation resistance : 5000M Ω /DC1000V
Withstanding voltage: AC3000V/1Min
Withstanding voltage: 20-6AWG 10.0mm²

● **Mechanical**

Temp.Range : -40°C~+105°C
Torque : 2.0Nm(17.5lb.in)
Strip length : 8-10mm

● **材质及电镀**

螺丝 : M5, 钢, 镀锌
触点材料: 紫铜, 镀锡
塑件 : PA66, UL94V-0

● **电气性能**

额定电压: 600V
额定电流: 63A
接触电阻: 20m Ω
绝缘电阻: 5000M Ω /DC1000V
耐电压 : AC3000V/1Min
使用线径: 20-6AWG 10.0mm²

● **机械性能**

温度范围: -40°C~+105°C
扭矩 : 2.0Nm(17.5lb.in)
剥线长度: 8-10mm



TSF 2.5

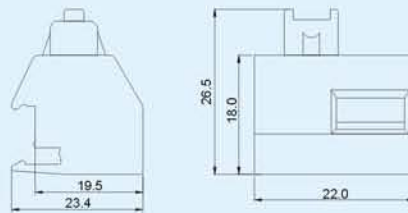

Pitch:22.0mm;Poles:1P

● **Material**

Screws : M3 steel Zinc plated
Contact : Copper, Tin plated
Housing : PA66, UL94V-0

● **Electrical**

Rated voltage : 250V
Rated current : 6.3A
Contact resistance : 20m Ω
Insulation resistance : 5000M Ω /DC1000V
Withstanding voltage: AC2000V/1Min
Withstanding voltage: 24-12AWG 2.5mm²

● **Mechanical**

Temp.Range : -40°C~+105°C
Torque : 0.5Nm(4.4lb.in)
Strip length : 8-10mm

● **材质及电镀**

螺丝 : M3, 钢, 镀锌
触点材料: 紫铜, 镀锡
塑件 : PA66, UL94V-0

● **电气性能**

额定电压: 250V
额定电流: 6.3A
接触电阻: 20m Ω
绝缘电阻: 5000M Ω /DC1000V
耐电压 : AC2000V/1Min
使用线径: 24-12AWG 2.5mm²

● **机械性能**

温度范围: -40°C~+105°C
扭矩 : 0.5Nm(4.4lb.in)
剥线长度: 8-10mm



TSP 4

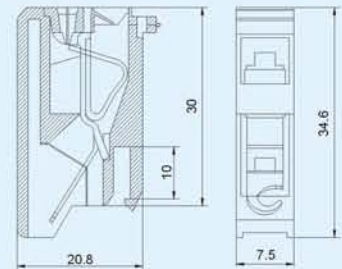

Pitch:7.5mm;Poles:1P

● **Material**

Wire guard: Stainless steel
Contact : Copper, Tin plated
Housing : PA66, UL94V-0

● **Electrical**

Rated voltage : 600V
Rated current : 20A
Contact resistance : 20m Ω
Insulation resistance : 5000M Ω /DC1000V
Withstanding voltage: AC3000V/1Min
Withstanding voltage: 24-10AWG 4.0mm²

● **Mechanical**

Temp.Range : -40°C~+105°C
Strip length : 10-12mm

● **材质及电镀**

簧片 : 不锈钢
触点材料: 紫铜, 镀锡
塑件 : PA66, UL94V-0

● **电气性能**

额定电压: 600V
额定电流: 20A
接触电阻: 20m Ω
绝缘电阻: 5000M Ω /DC1000V
耐电压 : AC3000V/1Min
使用线径: 24-10AWG 4.0mm²

● **机械性能**

温度范围: -40°C~+105°C
剥线长度: 10-12mm



TSPF 4

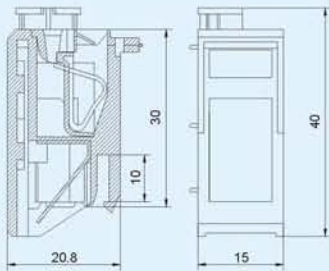

Pitch:15.0mm;Poles:1P

• **Material**

Wire guard: Stainless steel
Contact : Copper, Tin plated
Housing : PA66, UL94V-0

• **Electrical**

Rated voltage : 250V
Rated current : 10A
Contact resistance : 20m Ω
Insulation resistance : 5000M Ω /DC1000V
Withstanding voltage: AC3000/1Min
Withstanding voltage: 24-10AWG 4.0mm²

• **Mechanical**

Temp.Range : -40 $^{\circ}$ C~+105 $^{\circ}$ C
Strip length : 10-12mm

• **材质及电镀**

簧片 : 不锈钢
触点材料: 紫铜, 镀锡
塑件 : PA66, UL94V-0

• **电气性能**

额定电压: 250V
额定电流: 10A
接触电阻: 20m Ω
绝缘电阻: 5000M Ω /DC1000V
耐电压 : AC3000V/1Min
使用线径: 24-10AWG 4.0mm²

• **机械性能**

温度范围: -40 $^{\circ}$ C~+105 $^{\circ}$ C
剥线长度: 10-12mm